

CWDM INTEGRATED RF TRANSMITTER

High Bandwidth Directly Modulated DFB Laser Module

PRODUCT DATASHEET

The EM655 high bandwidth integrated module is a member of EM4's line of high performance single-frequency modules based on precision DFB laser technology.

The EM655 RF Transmitter integrates a high-bandwidth fiber-coupled DFB laser with both an ultra-low noise laser current source and temperature controller. The module also contains an optical isolator and back facet monitor detector readout amplifier.

The entire module operates from a single +5 V supply and offers a bi-directional bias adjust input that may be used to control the laser output power or finely adjust the laser oscillation frequency via chirp. The unit also incorporates a bi-directional temperature adjust input for coarse tuning of the laser oscillation frequency.

The module is designed and built using our high-reliability platform for defense components and incorporates an advanced ultra-low noise laser current source.

The EM655 drives the internal TEC with a class AB linear H-bridge and incorporates multiple layers of EMI protection. The device accepts a standard female DB9 connector for the application of power and low-frequency tuning signals while the RF input accepts a standard male 2.92 mm "K" connector.

The output optical fiber is available with or without PVDF furcation tubing terminated with a variety of standard optical connectors.



Models available

- 1310 nm with 18 mW output power
- C-band wavelength with 10 mW output power

Features

- Integrated current source
- Integrated temperature controller
- Integrated monitor detector amplifier
- SM or PM fiber with or without furcation tubing
- Simple interface
- Small form factor
- Operates from single +5V supply

Applications

- RF links
- CATV
- Seeding
- Sensing

Optical Characteristics

$T_{OP}=25^{\circ}\text{C}$, continuous wave, and beginning of life unless otherwise specified. All parameters measured after an initial 60s settling time. $V_{CC} = LE = 5.0\text{V}$ with Power Adjust and Temperature Adjust (V_{PA} and V_{TA}) pins open.

Parameter	Sym	Condition	Min	Typ	Max	Unit
Optical output power setpoint	P_{OP}	1310 nm devices	18			mW
		C-band devices	10			mW
Center wavelength	λ_{OP}	1310 nm devices, 25°C	$\lambda_{OP}-10$	λ_{OP}	$\lambda_{OP}+10$	nm
		C-band devices, 25°C	$\lambda_{OP}-1$	λ_{OP}	$\lambda_{OP}+1$	nm
Optical output power fluctuation ¹	ΔP_{OP}	1σ , $t_m=400\text{s}$, 0.1s avg and period		65	100	PPM
Long-term power fluctuation	ΔP_{OP}	1σ , $t_m=20\text{ hr}$, 0.1s avg, 18 s period		0.1	0.2	%
Temp dependent power drift	ΔP_T	$-10 \leq T_{OP} \leq 60^{\circ}\text{C}$			0.35	%
Temp dependent frequency drift	ΔF_T	$-10 \leq T_{OP} \leq 60^{\circ}\text{C}$			± 750	MHz/ $^{\circ}\text{C}$
Side mode suppression ratio	SMSR		30			dB
Polarization extinction ratio		with PM fiber only	17	20		dB
Optical isolation ²			30	35		dB
Relative intensity noise	RIN	P_{op} , 0.2-3 GHz		-150		dBc/Hz
Linewidth	$\Delta\nu$			1		MHz
Cold start settling time		$V_{CC} = V_{EN} 0 \rightarrow 5\text{ V}$			30	s
Rise time (hot start)	t_R	$V_{EN} = 0 \rightarrow 5\text{ V}$		30		ms
Fall time (hot standby)	t_F	$V_{EN}=5 \rightarrow 0\text{ V}$		5		μs
Back facet tracking over temp			-10		+10	%
Modulation bandwidth			10	12		GHz

¹ Power stability of this magnitude is strongly influenced by any movement of the fiber. To duplicate this stability measurement the fiber must be secured and motionless.

² Units are available without isolator (product series EM656). Devices without optical isolators are subject to mode-hops and are susceptible to back reflections. The wavelength stability devices with no optical isolator cannot be guaranteed.

Electrical Characteristics and Fiber Information

Parameter	Sym	Condition	Min	Typ	Max	Unit
Voltage supply	V _{CC}	across inputs		5		V
Current supply	I _{CC}				3	A
Laser enable high	LE _H		3.5			V
Laser enable low	LE _L				1.5	V
Laser enable input impedance	Z _{LE}			5		kΩ
Bias level adjust ³	V _{PA}	warning: see app notes	0		2.2	V
Bias level adjust input impedance	Z _{PA}	to 2V V _{REF}		1		kΩ
Bias level adjust bandwidth		-3dB		8		kHz
Temperature adjust	V _{TA}	warning: see app notes	1.5		3.5	V
Temp adjust input impedance	Z _{TA}	to 2.5 V V _{REF}		1		kΩ
Monitor detector output	V _{MON}	at P _{OP}	1		3	V
Bias tee inductance				53		nH

³ The peak of the RIN curve corresponds to the relaxation oscillation frequency of the laser which varies in proportion to the drive current above threshold by $f_{\text{relax}} \propto ((I_d/I_{\text{threshold}}) - 1)^{1/2}$. Customers employing this device in RIN sensitive applications should therefore be aware that reducing the bias level using the power adjust input will reduce performance. Reducing the bias level reduces the device modulation bandwidth by the same relationship.

Fiber Characteristics	
Fiber type	Single-mode, PM or non-PM
Core diameter	8 μm
Outer diameter	125 μm
Buffer diameter ⁴	250 μm
Buffer material ⁴	Acrylate
Minimum length	1 m
Minimum bend radius	35 mm
Output polarization	Parallel to slow axis
Connector ⁵	FC/APC

⁴ Optional 900 μm loose-tube PVDF buffer recommended for laboratory use.

⁵ Other connector options available, contact sales for more information.

Drawings and Performance Graphs

Outline drawing

Inches [mm]

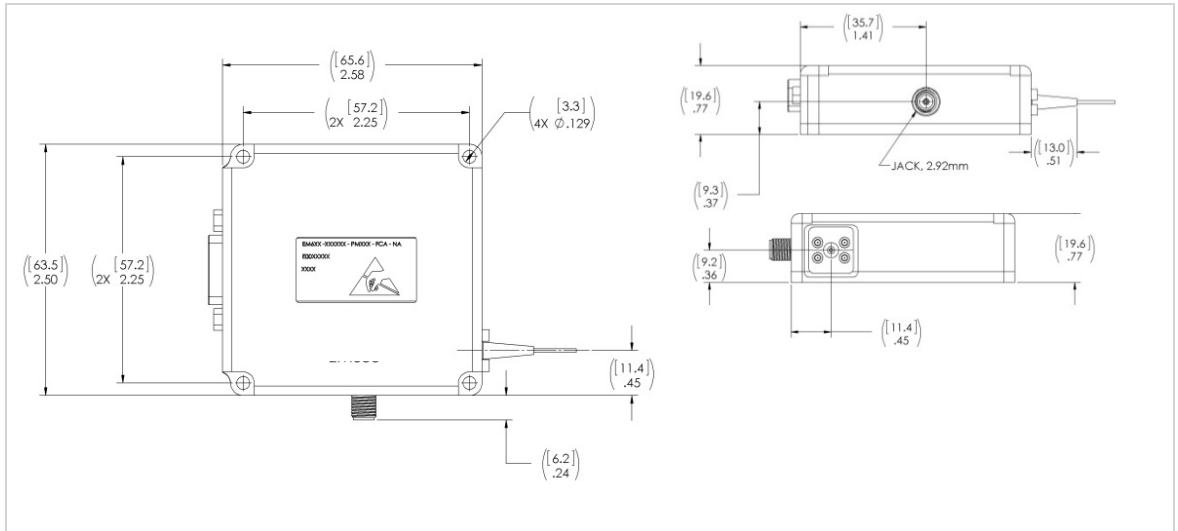

Typical RIN

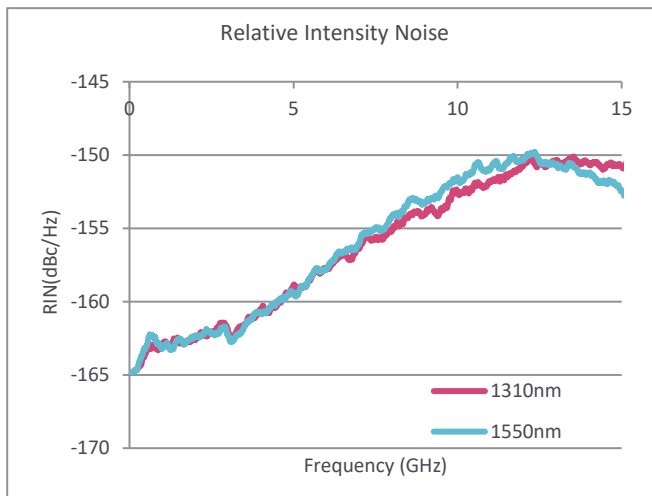

Typical RF performance

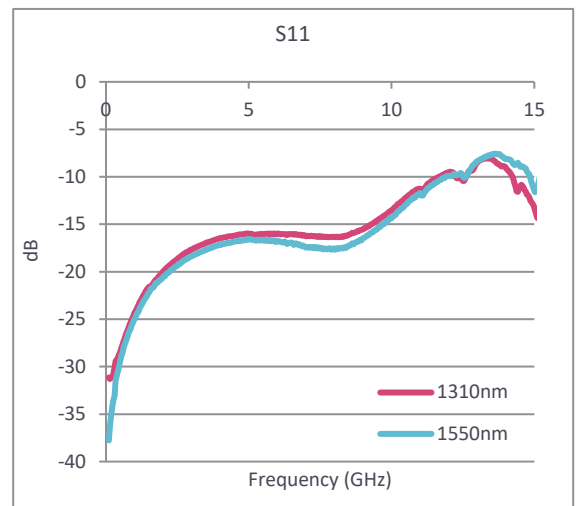
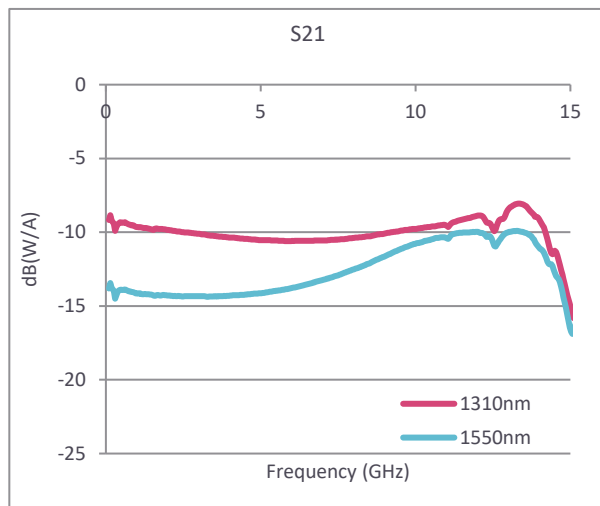

Drawings and Performance Graphs, Continued

Cold Start performance

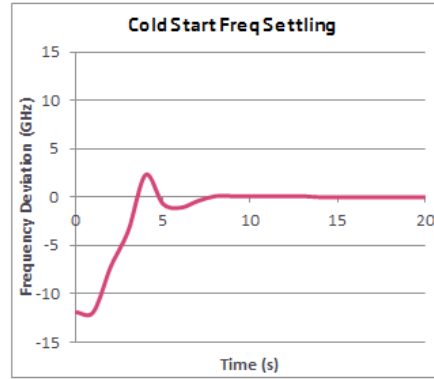
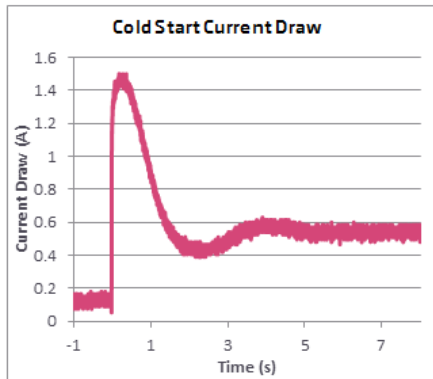

Operating temperature dependence

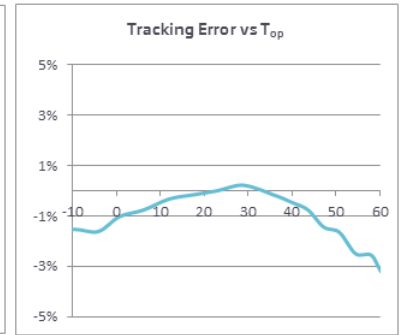
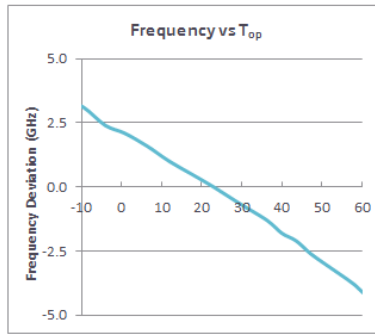
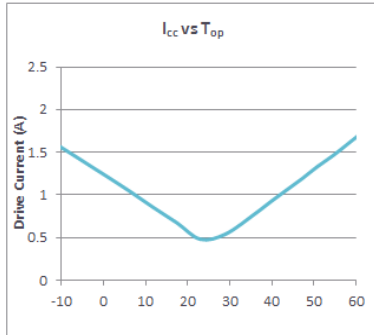

Laser enable rise/fall times

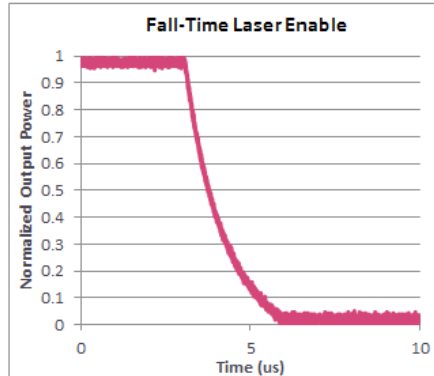
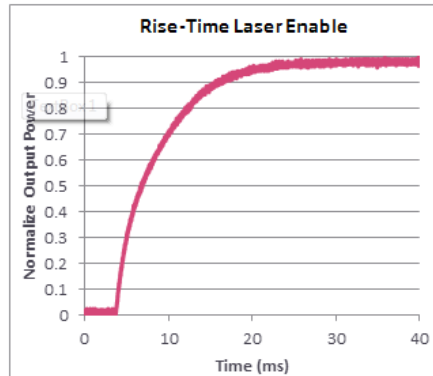

Temperature adjust and power adjust bandwidth

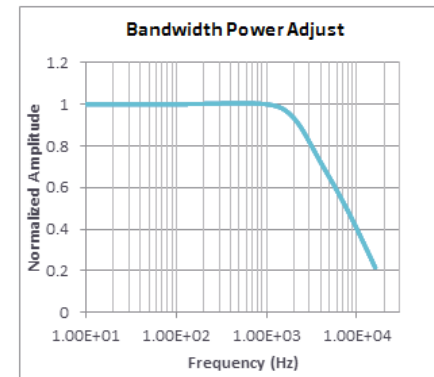
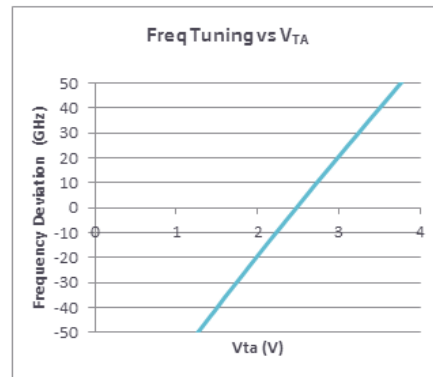

Pinout

Pin	Name	Description
1	VCC	Voltage supply
2	VCC	Voltage supply
3	GND	Ground connection
4	GND	Ground connection
5	GND	Ground connection
6	TA	Temperature adjust input
7	Vmon	Monitor voltage output
8	LE	Laser enable
9	PA	Bias level adjust input

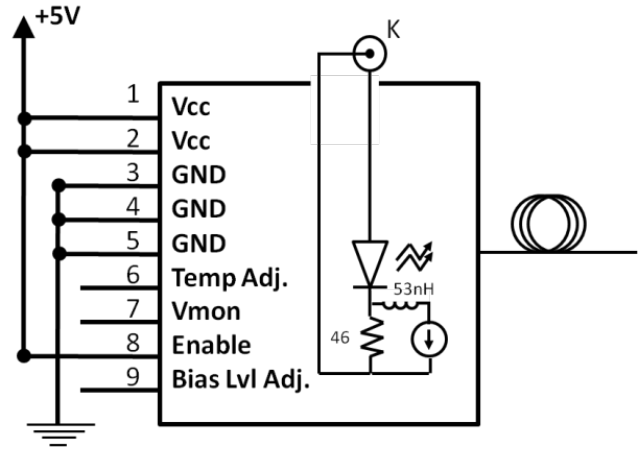

DB-9 Shield	Connected to connector shield only
RF (center pin)	Connected to laser cathode via 46Ω resistor
RF (shield)	DC coupled to laser anode (~1.3 VDC potential typ. to DC GND, must be isolated from DC supply GND)
Mating	DB-09F, standard DB-09 female/receptacle/socket connector
Connectors	2.92 mm male/plug

Absolute Maximum Ratings*	Sym	Min	Max	Unit
Storage temperature	T_{STG}	-40	+85	°C
Operating case temperature (at base of module)	T_{OP}	-10	+60	°C
Voltage supply	V_{CC}	4.6	5.5	V
Current supply	I_{CC}		3.5	A
Laser enable input voltage	V_{LE}	GND-0.3	$V_{CC} + 0.3$	V
Laser enable input current	I_{LE}		2	mA
Bias adjust input voltage (warning, see notes)	V_{PA}	0	2.4	V
Bias adjust input current source or sink (warning, see notes)		-3.5	3.5	mA
Temperature adjust input voltage (warning, see notes)	V_{TA}	0	5	V
Temp. adjust input current source or sink (warning, see notes)		-3.5	3.5	mA
Monitor detector output voltage	V_{MON}		V_{CC}	V
Monitor detector output current source or sink	I_{MON}	-15	15	mA
Optical output power	P_{OP}		20	mW

* Stresses beyond those listed under “absolute maximum ratings” may cause permanent damage to the device. These are stress ratings only and operation of the device at or beyond these conditions is not implied. Exposure to absolute maximum ratings for extended periods of time may affect device reliability.

Application Notes

Mounting

The EM655 is conductively cooled through its base and needs to be mounted using a thermal interface material to a customer supplied heatsink. EM4 recommends Panasonic PGS series pyrolitic graphite sheets, available in the US from Digi-Key Corporation. Do not use graphite sheets with adhesive backing. Care should be taken to keep the base temperature of the module between -10 - 60°C at all times during operation.

Noise Suppression

The EM655 is a no-compromises low noise integrated laser solution; the temperature controller output is class AB linear, there are no DC/DC converters in the module, the lowest noise components and architectures available are used along with heavy filtering and EMI shielding. Nevertheless, power supply ripple and noise should be minimized and the cable shield should be connected to the EM655 connector shield and tied to the appropriate signal at the power supply end of the cable.

Bias Level Adjust (PA)

The EM655 is designed to run in constant current mode with the drive current set for the as-ordered output power to achieve the highest possible performance. However, some applications require fine tuning of the laser bias current. The PA input provides this functionality, but its use carries an amount of risk. If bias adjustment is not required this input should be left open. Use of this input carries the potential to overdrive the laser and/or circuitry with the ability to destroy or drastically reduce the device lifetime. No internal protections on this input are provided, but the user is encouraged to clamp or otherwise limit the voltage and current that may be applied to this input.

The default operating power corresponds to an input of 2.05 V. For maximum reliability it is recommended that power only be reduced, although if required it can be driven as high as 2.2 V (corresponding to a 10% boost in output power). The safest method of using this input is to pull the voltage down using an external resistor or potentiometer to ground.

Applying a resistance to ground will create a voltage divide circuit between the external resistance and an internal resistance of 1 K to the 2.05 V reference. Damage due to overdrive will not be covered under warranty. Use of this input will likely decrease the performance of the EM655 by bypassing its internal ultra-low noise voltage reference.

Warning: The PA input must never be shorted directly to V_{CC} which would cause circuit malfunction or rapidly destroy the laser.

Temperature Adjust (TA)

The EM655 is designed to operate the laser chip at a constant temperature of 25 °C holding the output frequency within a window of 5 GHz. However, some applications require coarse tuning of the output frequency via temperature. In these cases, the laser may be tuned using the TA input. Temperature deviations of more than a few degrees (50 GHz in laser frequency) may result in decreased stability and increases the likelihood of the laser experiencing a longitudinal mode-hop. Use of this input carries the inherent potential of overdriving the TEC. The TA input is clamped to V_{CC} through integrated protection diodes. If V_{ta} is established before V_{CC} these clamp diodes will conduct. The input current should always be limited to ≤ 3.5 mA to prevent destruction of the clamp diodes. The safest method of driving this input is with a tristate output whose output is current limited when active, maintained at high impedance until V_{CC} is established, and whose output returns to high-impedance before V_{CC} is removed. The device warranty will not be honored for lasers with overdriven TECs. Use of this input also carries the likelihood of decreased frequency stability as it bypasses the internal ultra-low noise voltage reference.

Warning: The TA input must never be shorted directly to V_{CC} or ground which would cause circuit malfunction or rapidly destroy the laser.

Grounding, DC to RF

Care must be taken with grounding, cabling, and connections due to the amount of current the module consumes. Make sure that the voltage on pins PA/TA reference ground as close to the EM655 as possible if either input is connected.

- DO NOT connect the cable shield to ground at both ends of the cable to avoid producing a ground loop.
- DO NOT connect the EM655 housing to ground to avoid producing a ground loop.

The shield of the RF input 2.92 mm connector is connected to the laser anode and the center conductor to the laser cathode via the RF matching resistor. Care should be taken that the connection of an RF source does not result in a DC leakage path. The ground of the RF source must be isolated from the ground of the DC power supply, as 1.3 V typical bias voltage difference will exist between the RF ground and DC ground due to the laser diode bias voltage. In addition, shorting of the RF connector places an electrical short in parallel with the laser which will prevent the laser from operating.

Startup Considerations

The EM655 consumes a considerable amount of current in the startup phase and when operating at temperature extremes. A voltage source plus cabling able to deliver the maximum specified current at no less than the minimum voltage is therefore needed. Current limiting below the specified maximum during the startup phase will result in an internally measured drive voltage lower than specified. This condition can result in permanent, non-warrantable damage to the device.

Warning: If the user fails to sequence the supplies as described in the Power and Temperature Adjust sections of this document and Applications Note DS-7047, the device will immediately suffer non-warrantable damage or destruction.

Power Supply

This device requires between 4.6 V and 5.5 V as measured from the V_{CC} to ground terminals. These voltages must be maintained for currents ranging from 0-3A necessitating the use of short wires and/or large AWG wire.

Warning: Failure to supply sufficient voltage at the device terminals may result in excess current draw and permanent, non-warrantable damage. If the device draws 3A for more than 10 seconds, turn off power and check for excessive wiring resistance or a baseplate temperature outside the operational range.

Additional Information

Be sure to check the website for the latest application information for this device. Application Note DS-7047 covers general usage of the EM655 along with information particular to tuning via temperature or chirp. If you plan to tune this device, we highly recommended that you read this application note.

Ordering Information

Example part number: EM655-193414-010-SM900-FCA-50

		①	②	③	④	⑤	⑥											
E	M			-				-				-	F	C	A	-	5	0
①	Model	Standard (with internal isolator)					Without internal isolator ¹											
	Code	655					656											
②	Wavelength	1310 nm					C-band options											
	Code	228849					XXXXXX (see chart below)											
③	Power	10 mW					18 mW											
	Code	010 (for c-band lasers)					018 (for 1310nm lasers)											
④	Fiber	SM fiber, 900 um loose buffer			PM fiber, 900 um tight buffer			PM fiber, 900 um loose buffer										
	Code	SM900			PM250			PM900										
⑤	Connector ²	FC/APC ²																
	Code	FCA																
⑥	Bias T	50 Ω																
	Code	50																

¹ SMSR not specified for lasers without isolators.

² Other connector options available, contact sales for more information.

Available C-band channel frequencies (wavelengths)

Standard center C-band option in bold.

Frequency	Wavelength
196.300 THz	1527.22 nm
196.200 THz	1527.99 nm
196.100 THz	1528.77 nm
196.000 THz	1529.55 nm
195.900 THz	1530.33 nm
195.800 THz	1531.12 nm
195.700 THz	1531.90 nm
195.600 THz	1532.68 nm
195.500 THz	1533.47 nm
195.400 THz	1534.25 nm
195.300 THz	1535.04 nm
195.200 THz	1535.82 nm
195.100 THz	1536.61 nm
195.000 THz	1537.40 nm
194.900 THz	1538.19 nm
194.800 THz	1538.98 nm

Frequency	Wavelength
194.700 THz	1539.77 nm
194.600 THz	1540.56 nm
194.500 THz	1541.35 nm
194.400 THz	1542.14 nm
194.300 THz	1542.94 nm
194.200 THz	1543.73 nm
194.100 THz	1544.53 nm
194.000 THz	1545.32 nm
193.900 THz	1546.12 nm
193.800 THz	1546.92 nm
193.700 THz	1547.72 nm
193.600 THz	1548.51 nm
193.500 THz	1549.32 nm
193.400 THz	1550.12 nm
193.300 THz	1550.92 nm
193.200 THz	1551.72 nm

Frequency	Wavelength
193.100 THz	1552.52 nm
193.000 THz	1553.33 nm
192.900 THz	1554.13 nm
192.800 THz	1554.94 nm
192.700 THz	1555.75 nm
192.600 THz	1556.55 nm
192.500 THz	1557.36 nm
192.400 THz	1558.17 nm
192.300 THz	1558.98 nm
192.200 THz	1559.79 nm
192.100 THz	1560.61 nm
192.000 THz	1561.42 nm
191.900 THz	1562.23 nm
191.800 THz	1563.05 nm
191.700 THz	1563.86 nm
191.600 THz	1564.68 nm

For further information

EM4
 T: +1 781-275-7501
 E: sales@em4inc.com

EM4inc.com